

ic\_-  
\_Thermoelectric\_Generator\_Hy  
brid\_Using\_LabVIEW\_Simulator.  
pdf  
*by*

---

**Submission date:** 09-Dec-2021 04:07PM (UTC+0700)

**Submission ID:** 1725366531

**File name:** ic\_-\_Thermoelectric\_Generator\_Hybrid\_Using\_LabVIEW\_Simulator.pdf (1.39M)

**Word count:** 4010

**Character count:** 20145

## Performance Comparison Between Hot Mirror and Cold Mirror as a Beam Splitter on Photovoltaic - Thermoelectric Generator Hybrid Using LabVIEW Simulator



Zuryati Djafar\*, Andi Zahirah Salsabila, Wahyu H. Piarah

Mechanical Engineering Department, Faculty of Engineering, Universitas Hasanuddin, Jl. Malino, Borongloe, Bontomarannu, Kabupaten Gowa, Sulawesi Selatan 92171, Indonesia

Corresponding Author Email: [zuryatidjafar@unhas.ac.id](mailto:zuryatidjafar@unhas.ac.id)

<https://doi.org/10.18280/ijht.390524>

Received: 17 July 2021

Accepted: 22 September 2021

### Keywords:

*cold mirror, hot mirror, light spectrum, output power, photovoltaic, thermoelectric generator*

### ABSTRACT

Solar energy can be converted into electrical energy using photovoltaic (PV) and thermoelectric generators (TEG). In order to increase the effectiveness of energy absorption, a hot mirror or cold mirror spectrum separator is used. In this study, a simulation was carried out to see the effect of the cold mirror and hot mirror spectrum separator on the performance of the PV-TEG hybrid. Simulations are carried out using the LabVIEW program. The standard for the solar radiation spectrum used is AM1.5D. The incoming radiation is transmitted using a Fresnel lens to make it more focused and then transmitted to a cold mirror or hot mirror, where the spectral irradiance will be halved. Spectral irradiance with a wavelength of 400-690 nm will be directed to PV and a wavelength of 710-1150 nm will be directed to TEG. From the PV-TEG hybrid modeling and simulation using the LabVIEW program, the resulting power and efficiency are 240.635 W/m<sup>2</sup> and 27% respectively for cold mirror and 228.835 W/m<sup>2</sup> and 25.76% for hot mirror.

23

## I. INTRODUCTION

Solar energy is the energy that is abundant, continuous, and environmentally friendly because it does not produce harmful carbon emissions like burning fossil fuels. Solar energy is included in the renewable energy group.

Regarding on the statement above, numerous researches on the development of renewable energy have been conducted, one of which is the development of the use of solar energy. The history of human civilization records that solar energy has greatly influenced all aspects of human life and the environment since the beginning of life in this world [1].

The rate of energy emitted by the sun arriving in the atmosphere is 1386 W/m<sup>2</sup>, and those arriving on the earth's surface can reach 1000 W/m<sup>2</sup> in clear weather conditions. This is due to the influence of the earth's rotation on its axis, the earth's circulation on its trajectory and the gases in space [2].

The main problem in the utilization of solar energy is the day and night factor which always alternates so that the continuity of solar energy acquisition is always cut off at night. However, besides being able to be used directly during the day with the aid of an energy conversion device, it can also be stored in the battery for use at night [1].

As explained previously, solar energy can be converted into electrical energy using energy converters such as solar cells or photovoltaic (PV) cells. The results of the research according to Makki et al. [3] showed that PV can absorb up to 80% of solar radiation, but not all of it can be converted into electrical energy but become heat waste which can increase cell temperature that can cause a decrease in PV efficiency.

Research on PV cooling techniques to maintain temperature stability by utilizing heat waste has been carried out using gas

and liquid fluids [4-6] and the use of thermoelectric coolant (TEC) [7].

In addition to the thermoelectric coolant (TEC), there is also a thermoelectric generator (TEG) which is a power generating device the resulted from the temperature difference between the two sides of the TEC. The research advancement by stacking up PV and TEG to increase the output power and increase the efficiency has been conducted by Chang et al. [8].

Research on the combination of photovoltaic and thermoelectric generators known as PV-TEG has been carried out by several researchers [9-15] with various configurations where each PV and TEG receive direct sunlight.

Another further development model of the PV-TEG hybrid is to separate the spectrum of infrared (IR) light, ultraviolet (UV) light, and visible (VL) light from the sun [16-21] which is known as a beam splitter. This development was carried out because it wanted to produce maximum performance of PV and TEG.

Hariyanto et al. [22] have conducted research on simulating PV-TEG hybrid with beam splitter hot mirrors using the standard AM1.5D solar spectrum and a hot mirror, where wavelengths 400-690 nm are transmitted to PV and 690-1150 nm are reflected to them. TEG. The result is a maximum total power of 0.554 W with an efficiency of 67.25%. Another research on simulated PV-TEG hybrid with beam splitter hot and cold mirrors using low intensity have been conducted by Piarah et al [23] using AM1.5G solar spectrum at variations of 0.05, 0.1, 0.25, 0.50 and 0.7 Sun. The light spectrum is concentrated using a Fresnel lens and then transmitted to a spectrum separator (hot and cold mirrors). The simulation results showed that by using cold mirror, the maximum total power is better than hot mirror.

Matlab Software was used in previous simulations by Hariyanto et al. [22] and Piarah et al. [23]. The Matlab software uses a high-level programming language so it requires more knowledge to operate it. Apart from Matlab software, there is also LabVIEW software. LabVIEW software is a programming software produced by National Instruments with a different concept. Like other programming languages, namely C++, Matlab or Visual Basic, LabVIEW also has the same function and role, the difference is that LabVIEW uses a graphical or block diagram-based programming language while other programming languages use a text base. LabVIEW program is known as VI or Virtual Instruments because its appearance and operation is similar to an instrument [24]. In this article, the authors use LabVIEW software to compare the performance of using beam splitter hot and cold mirrors on PV-TEG hybrid with AM1.5D solar spectrum.

## 2. RESEARCH METHODS

This research was conducted to compare the simulation results using LabVIEW software when using beam splitter hot and cold mirrors on PV-TEG hybrid with AM1.5D solar spectrum. The incoming light is concentrated by the Fresnel lens to be directed to the hot mirror or cold mirror. Then the hot mirror or cold mirror will separate the visible light wave spectrum (VL) on the one hand and infrared (IR) on the other. The light waves that have been separated will be forwarded to the PV and TEG modules respectively. This research begins by identifying the input parameters, then analyzing a mathematical model to determine the output. The input-output simulation is carried out in LabVIEW by first making a block diagram for the calculation of each input parameter. The results of the simulation are in the form of graphs and data that describe the characteristics of PV and TEG in various temperature.

The different configurations of using hot mirror and cold mirror beam splitters in the hybrid PV-TEG scheme can be seen in Figure 1 and Figure 2 below:

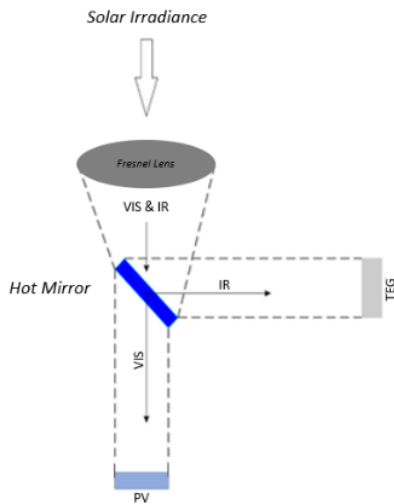

Figure 1. Schematic of PV-TEG hybrid using beam splitter hot mirror

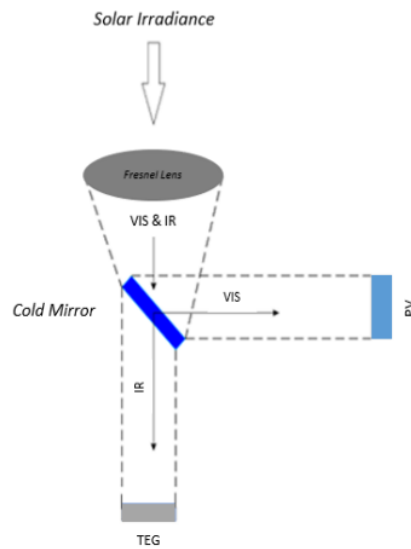

Figure 2. Schematic of PV-TEG hybrid using beam splitter cold mirror

When using hot mirror, the reflected light is directed to the TEG the transmitted rays are directed to the PV. As for the cold mirror, the reflected light is directed to PV and the transmitted light is directed to TEG.

### 2.1 Photovoltaic model (PV)

The PV cell module used is a single diode PV cell with the type of Amorphous Silicon (a-Si). PV modeling is depicted with a series of equivalents as shown in Figure 3.

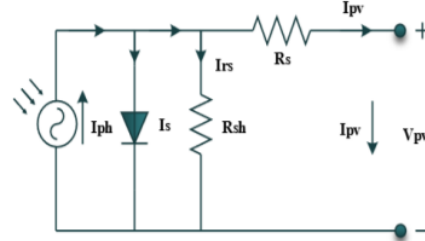

Figure 3. PV Single diode equivalent circuit [25]

The image above is then expressed in the following equations [26]:

$$I_{pv} = I_{ph} - I_s - I_{rs} \quad (1)$$

$$I_{ph} = [I_{sc} + K_i(T - T_o)] \left( \frac{G}{G_o} \right) \quad (2)$$

$$I_{rs} = I_{scr} \left[ \exp \left( \frac{qV_{oc}}{N_s kAT} \right) - 1 \right] \quad (3)$$

$$I_s = I_{rs} \left( \frac{T}{T_o} \right)^3 \exp \left[ \frac{qE_g}{Ak} \left( \frac{1}{T_o} - \frac{1}{T} \right) \right] \quad (4)$$

and the following Eqns. (5) and (6) [27]:

$$I_{pv} = I_{ph} - I_s \exp \left[ \frac{q(V_{vp} + I_{pv}R_S)}{kAT} \right] \quad (5)$$

$$I_{pv} = I_{ph} - I_s \exp \left[ \frac{qV_{vp}}{kAT} \right] - \frac{V_{vp}}{R_{SH}} \quad (6)$$

Also Zainal and Yusuf [26] obtained the following Eq. (7):

$$I_{pv} = N_p * I_{ph} - N_p * I_s \left[ \exp \left( \frac{qV_{vp} + I_{pv}R_S}{N_s kAT} \right) - 1 \right] - \frac{V_{vp} + I_{pv}R_S}{R_{SH}} \quad (7)$$

$I_{pv}$  is the PV output current,  $I_{ph}$  is the generated photon current,  $I_s$  is the diode current,  $R_S$  is the alternating current (resistance),  $I_{sc}$  is the short circuit current,  $K_i$  is the current conductivity (0.0023 A/C), T is PV temperature,  $T_o$  is standard temperature, G is irradiation,  $G_o$  is standard irradiation,  $I_{scr}$  is standard short circuit current,  $V_{oc}$  is open-circuit voltage, q is electron charge ( $1.602 \times 10^{-19}$  C),  $N_s$  is number of serial cells in module,  $N_p$  is the number of parallel cells in the module, k is the Boltzman constant ( $1.38 \times 10^{-23}$  J), A is the ideal diode factor for amorphous silicon = 1),  $E_g$  is the band gap energy,  $R_S$  is the series resistance and  $R_{SH}$  is parallel resistance.

PV performance is calculated by the equation [28]:

$$P_{in} = GA_{pv} \quad (8)$$

$$FF = \frac{I_{MP}V_{MP}}{I_{sc}V_{oc}} \quad (9)$$

$$P_{out} = V_{oc}I_{sc}FF \quad (10)$$

$$\eta_{pv} = \frac{I_{MP}V_{MP}}{GA_{pv}} \quad (11)$$

$P_{in}$  is the PV input power,  $P_{out}$  is the PV output power, FF is the fill factor,  $\eta_{pv}$  is the PV efficiency.  $I_{MP}$  is the current at the point of maximum power,  $V_{MP}$  is the voltage at the point of maximum power, G is the irradiation and  $A_{pv}$  is the surface area. The specific values of the parameters used are:  $G = 1$  Sun = 317.4374 W/m<sup>2</sup>,  $A_{pv} = 0.0025$  m<sup>2</sup>. The  $I_{MP}$  value is obtained from the calculation results in equation (7), the  $V_{MP}$  value is varied from 0 to 2.5 Volts, and the value of  $V_{oc} = 2.4$  Volts and the value of  $I_{sc} = 0.89769$  A is obtained from the PV specifications used.

Eqns. (1) - (11) are inputted into LabVIEW to make block diagram calculations and input/output relationships as in Figure 4. The results are displayed on the front panel as in Figure 5. In this model the TEG functions in dynamic conditions, because in practice the TEG input temperature fluctuates greatly over time. The analysis used to determine current, voltage and power is to create an equivalent scheme similar to PV (see Figure 6) by considering the Seebeck effect.

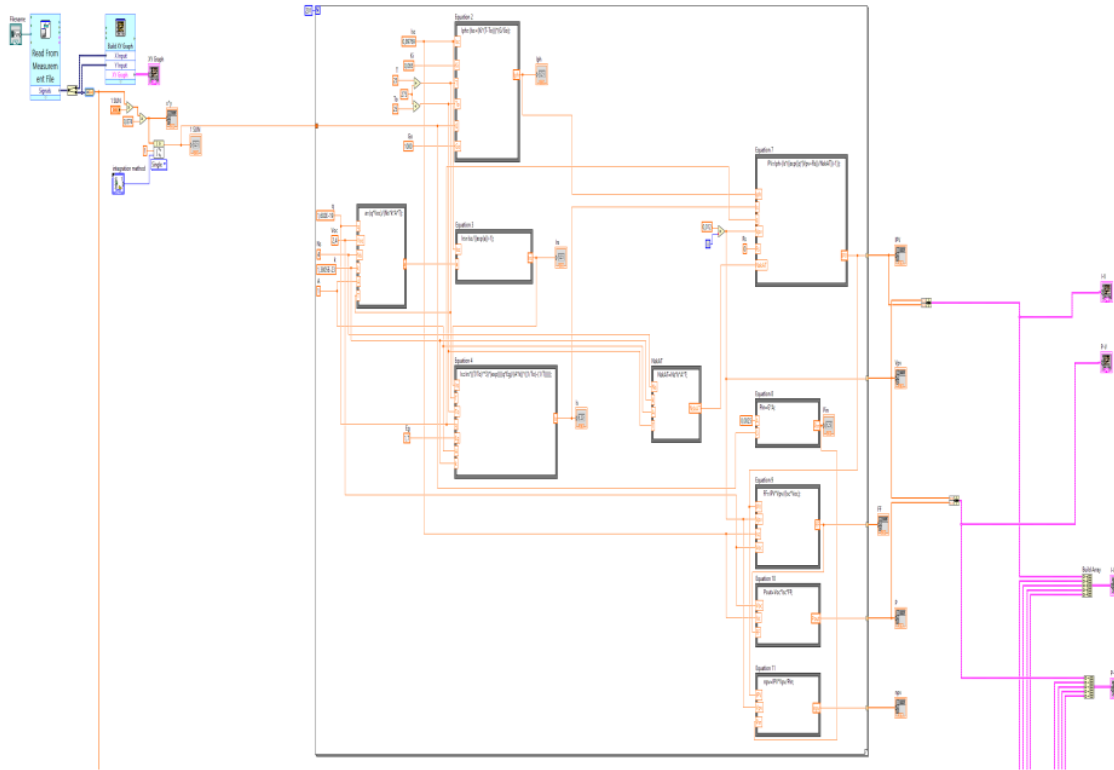

Figure 4. Block diagram of (1) - (11) equations

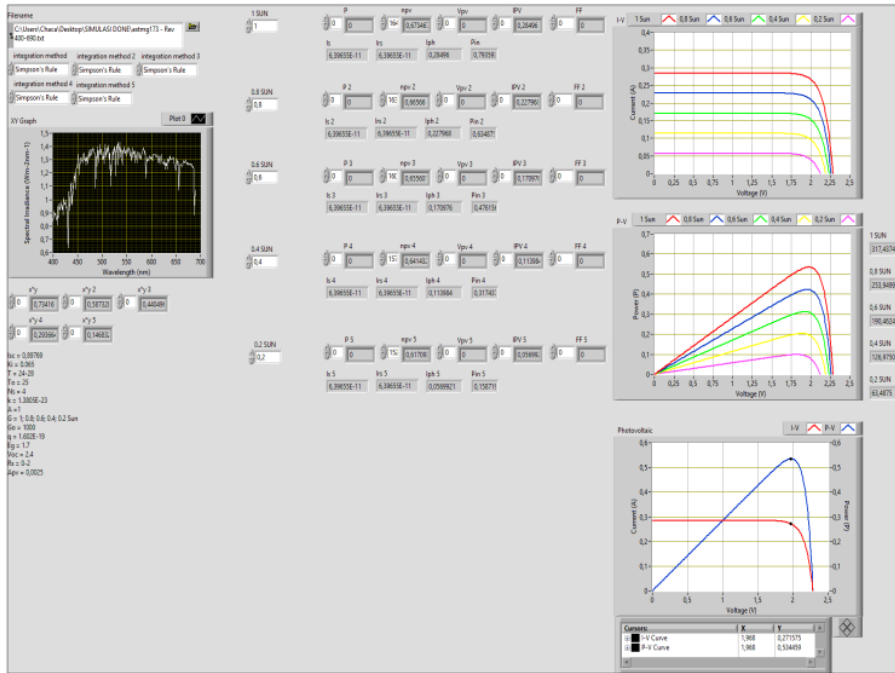

Figure 5. Front panel of PV simulation

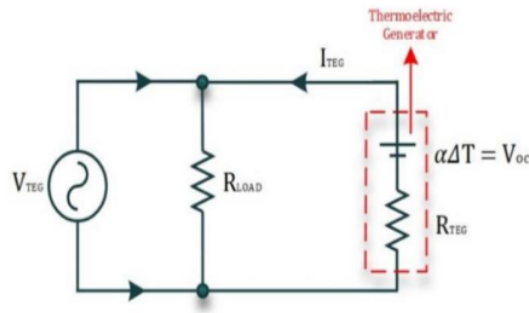

Figure 6. Schematic of the internal TEG resistance at maximum power [29]

The TEG used is the SP1848-27145 SA type where the analysis at steady-state conditions is carried out to verify the TEG electrical parameters that are in the module specifications. The heat absorbed by the  $Q_H$  hot side is expressed by the equation [29]:

$$Q_H = \alpha I T_H + K(T_H - T_C) - 0.5 R I^2 \quad (12)$$

$$K = \frac{k A_{TEG}}{t} \quad (13)$$

$T_H$  is the hot side temperature,  $T_C$  is the cold side temperature,  $I$  is the TEG current,  $\alpha$  is the Seebeck coefficient,  $R$  is the internal resistance,  $k$  is thermal conductivity,  $A_{TEG}$  is the surface area of TEG and  $t$  is the thickness of TEG. The calculation of the current-voltage TEG is stated with the following equations [29]:

$$V_{oc} = \alpha \Delta T \quad (14)$$

$$I_{TEG} = \frac{\alpha \Delta T}{R_{TEG} + R_{Load}} \quad (15)$$

$$V_{TEG} = \frac{\alpha \Delta T}{R_{TEG} + R_{Load}} \cdot R_{Load} \quad (16)$$

$$P_{TEG} = \frac{(\alpha \Delta T)^2 \cdot R_{Load}}{(R_{TEG} + R_{Load})^2} \quad (17)$$

$$P_{TEG} = \frac{(V_{oc})^2}{4 R_{TEG}} \quad (18)$$

$$\eta_{TEG} = \frac{V_{TEG} I_{TEG}}{Q_H} \quad (19)$$

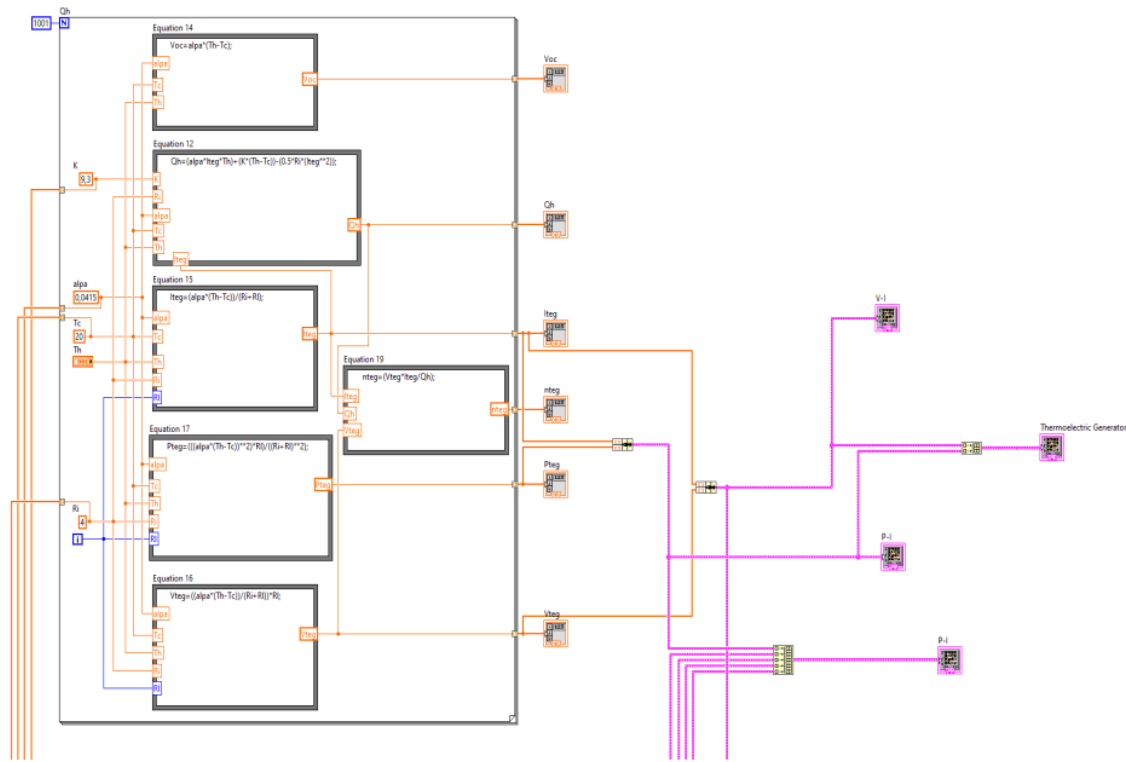

Figure 7. Block diagram of (12) - (19) equations

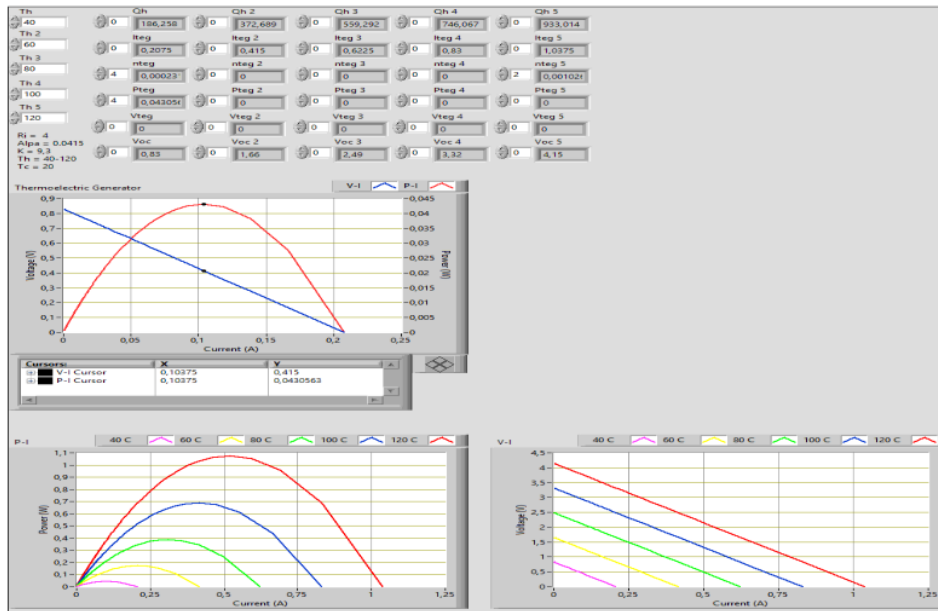

Figure 8. Front panel of TEG simulation

19  $V_{OC}$  is the open-circuit voltage,  $I_{TEG}$  is the TEG output current,  $V_{TEG}$  is the TEG voltage,  $P_{TEG}$  is the TEG output power,  $\alpha$  is the Seebeck coefficient of the semiconductor material,  $\eta_{TEG}$  is the efficiency,  $R_{TEG}$  is the internal resistance

of the TEG, and  $R_{Load}$  is the external resistance. Eqns. (12) - (19) are entered into LabVIEW to make a block diagram for the calculation of input/output as in Figure 7. The results are displayed on the front panel as shown in Figure 8.

### 3. RESULTS AND DISCUSSION

#### 3.1 Comparison of PV simulation results

As a comparative parameter, a current curve I with a voltage V and a power curve P with a voltage V are used. The characteristics of the curve obtained are identical to those obtained by Schweber [30] and Piarah et al. [23]. In Piarah et al, using a low intensity of 0.05 Sun produced 0.01976 W of power for cold mirror and 0.01867 W for hot mirror.

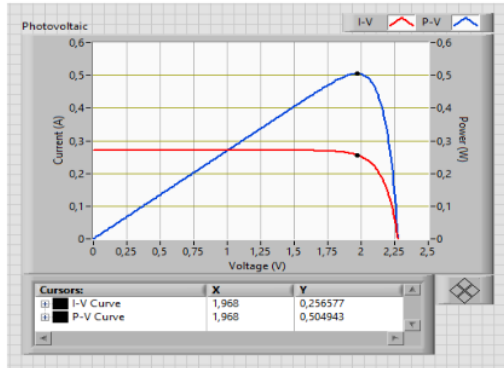

(a)

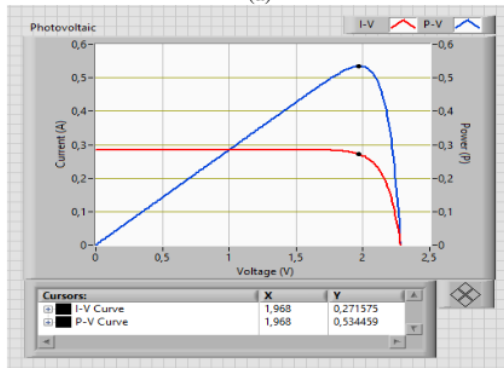

(b)

Figure 9. Simulation results of I-V Curves and P-V Curves on Photovoltaics (a) Cold mirror (b) Hot mirror

Figure 9 shows the simulation results of the I-V curve and the P-V curve using cold and hot mirrors, respectively. The power and efficiency produced by using a beam splitter cold mirror is 0.534 W and 67.339% while using a beam splitter hot mirror the resulting power and efficiency are 0.5049 W and 67.156% respectively.

#### 3.2 Comparison of TEG simulation results

Figure 10 shows a comparison of the TEG simulation results using the respective beam splitter cold and hot mirrors. Shown to have similar power output characteristic with a maximum power of 0.043 W but different efficiency (further explain in 3.3).

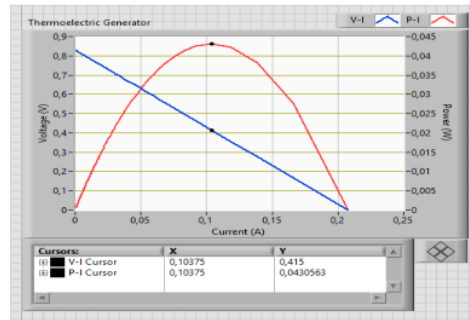

(a)

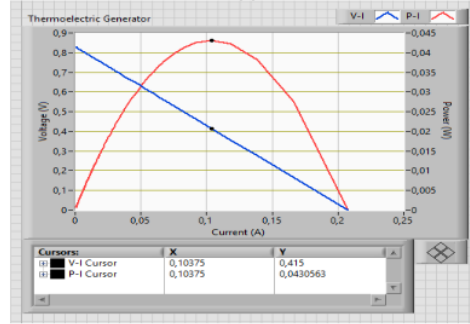

(b)

Figure 10. Simulation results of TEG (a) Cold mirror (b) Hot mirror

#### 3.3 Comparison of PV temperature change models

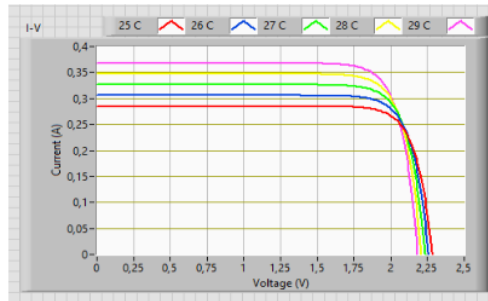

(a)

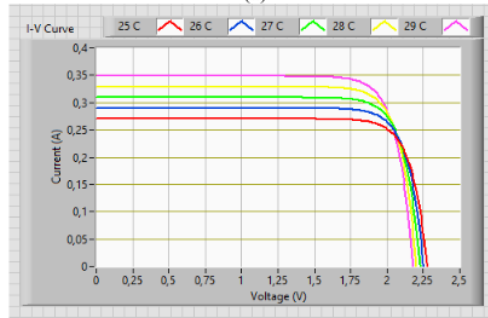

(b)

Figure 11. Curve of temperature change I-V (a) Cold mirror (b) Hot mirror

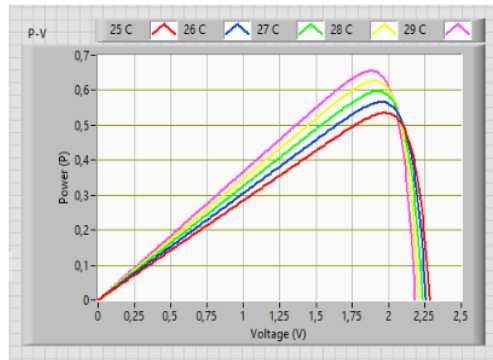

(a)

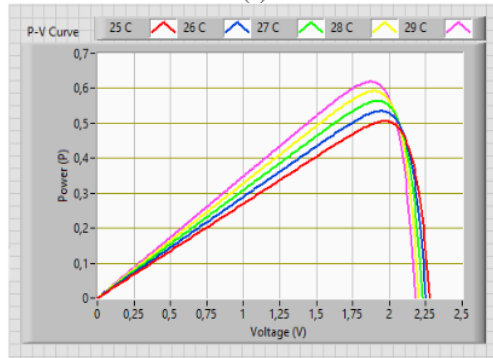

(b)

**Figure 12.** Curve of change in temperature of P-V (a) Cold mirror (b) Hot mirror

Figures 11 and 12 show the comparison of the simulation results of the I-V curve and the P-V curve with the temperature change input (25, 26, 27, 28, and 29°C) and the intensity input for the cold mirror beam splitter is 317.4374 W/m<sup>2</sup> while the hot mirror is 300.7302 W/m<sup>2</sup>.

There are differences that is resulted from each beam splitter used where the maximum power for the cold mirror is 0.65441 W and for the hot mirror is 0.618196 W. Further detail for the use of cold mirror can be seen in Table 1, while beam splitter hot mirror in Table 2.

**Table 1.** Cold mirror

Temperature (°C)	I <sub>sc</sub> (A)	V <sub>oc</sub> (V)	I <sub>mp</sub> (A)	V <sub>mp</sub> (V)	P <sub>mp</sub> (W)
25	0,2850	2,2820	0,2716	1,9680	0,5345
26	0,3056	2,2574	0,2912	1,9440	0,5660
27	0,3262	2,2326	0,3088	1,9320	0,5965
28	0,3469	2,2075	0,3281	1,908	0,6260
29	0,3675	2,1822	0,3474	1,884	0,6544

**Table 2.** Hot mirror

Temperature (°C)	I <sub>sc</sub> (A)	V <sub>oc</sub> (V)	I <sub>mp</sub> (A)	V <sub>mp</sub> (V)	P <sub>mp</sub> (W)
25	0,2700	2,2764	0,2566	1,9680	0,5050
26	0,2895	2,2518	0,2751	1,9440	0,5347
27	0,3091	2,2269	0,2935	1,9200	0,5635
28	0,3286	2,2018	0,3119	1,8960	0,5914
29	0,3482	2,1766	0,3302	1,8720	0,6182

### 3.4 Comparison of TEG temperature change models

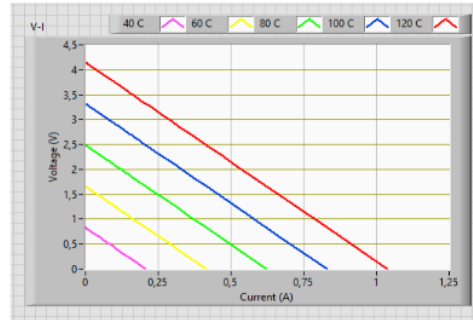

(a)

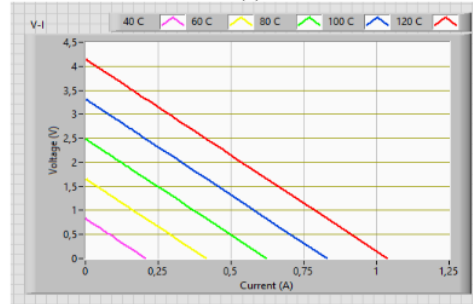

(b)

**Figure 13.** Temperature change curve V-I (a) Cold mirror (b) Hot mirror

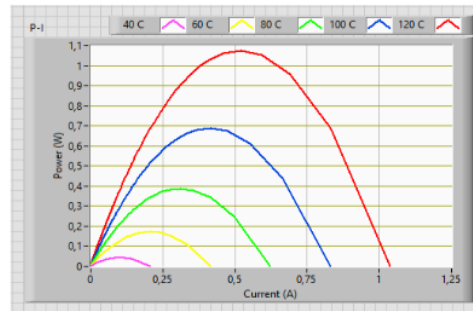

(a)

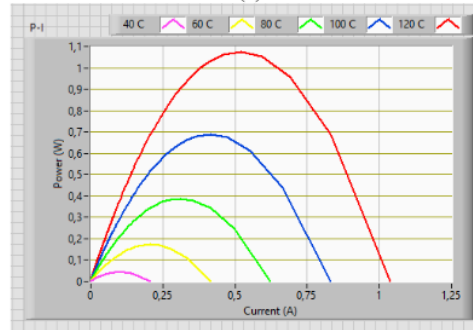

(b)

**Figure 14.** Curve of change in temperature of P-I (a) Cold mirror (b) Hot mirror

Figures 13 and 14 show the comparison of the simulation results of the V-I and P-I curves for TEG with changes in the temperature of the hot side  $T_h$ , respectively 40, 60, 80, 100, and 120°C, and the cold side input  $T_c$  is constant at 20°C using each beam splitter cold and hot mirrors. The results obtained are the same output power, but there are differences in the value of efficiency obtained due to differences in intensity values leading to TEG. For instance, at a temperature of 40°C, the use of a beam splitter cold mirror produces a power of 0.043 W and an efficiency of 9.8%, while using a beam splitter hot mirror the resulting power and efficiency are 0.043 W and 9.36%.

#### 4. CONCLUSIONS

The result of PV-TEG hybrid simulation using beam splitter cold mirror and hot mirror with AM1.5D spectrum has different results. The use of cold mirror beam splitter showed more effective than hot mirror beam splitter. This is indicated by the value of the sun's intensity reflected using a cold mirror to the PV 317.4374 W/m<sup>2</sup> compared to a hot mirror of 300.7302 W/m<sup>2</sup>. In addition, the power and efficiency of the PV-TEG hybrid simulation using a cold mirror beam splitter is 240.635 W/m<sup>2</sup> and is 27% greater than the hot mirror beam splitter that is 228.835 W/m<sup>2</sup> and 25.76%.

#### REFERENCES

- [1] Pudjanarsa, A., Nursuhud, D. (2013). *Energy Conversion Engine*. ISBN: 978-979-29-0483-3. Andi. Yogyakarta. [In Bahasa].
- [2] Himran, S. (2019). *Solar Energy*. ISBN: 978-623-01-1168-6. Andi. Yogyakarta. [In Bahasa].
- [3] Makki, A., Omer, S., Sabir, H. (2015). Advancements in hybrid photovoltaic systems for enhanced solar cells performance. *Renewable and Sustainable Energy Reviews*, 41: 658-684. <https://doi.org/10.1016/j.rser.2014.08.069>
- [4] Chow, T.T., He, W., Ji, J. (2006). Hybrid photovoltaic-thermosiphon water heating system for residential application. *Solar Energy*, 80(3): 298-306. <https://doi.org/10.1016/j.solener.2005.02.003>
- [5] Li, M., Li, G. L., Ji, X., Yin, F., Xu, L. (2011). The performance analysis of the Trough Concentrating Solar Photovoltaic/Thermal system. *Energy Conversion and Management*, 52(6): 2378-2383. <https://doi.org/10.1016/j.enconman.2010.12.039>
- [6] Huang, B.J., Lin, T.H., Hung, W.C., Sun, F.S. (2001). Performance evaluation of solar photovoltaic/thermal systems. *Solar Energy*, 70(5): 443-448. [https://doi.org/10.1016/S0038-092X\(00\)00153-5](https://doi.org/10.1016/S0038-092X(00)00153-5)
- [7] Kane, A., Verma, V. (2013). Performance enhancement of building integrated photovoltaic module using thermoelectric cooling. *International Journal of Renewable Energy Research*, 3(2): 320-324.
- [8] Chang, H., Kao, M., Cho, K., Chen, S., Chu, K., Chen, C. (2011). Integration of CuO thin film and dye-sensitized solar cells for thermoelectric generators. *Current Applied Physics*, 11(4): S19-S22. <https://doi.org/10.1016/j.cap.2010.12.039>
- [9] Hashim, H.T. (2011). Full-spectrum solar energy harvesting using nanotechnology enabled photovoltaic/thermoelectric hybrid system. PhD thesis, Cardiff University.
- [10] Wang, N., Han, L., He, H., Park, N.-H., Koumoto K. (2011). A novel highperformance photovoltaic-thermoelectric hybrid device. *Energy Environ. Sci.*, 4(9): 3676-3679. <https://doi.org/10.1039/C1EE01646F>
- [11] Demak R.K., Hatib R. (2016). Comparison of solar energy with halogen lamps on the efficiency of multicrystalline photovoltaic modules. In *Bahasa Indonesia: Komparasi Energi Surya dengan lampu Halogen Terhadap Efisiensi Modul Photovoltaic Tipe Multicrystalline*, 7(1): 625-633.
- [12] Van Sark, W.G.J. H.M. (2011). Feasibility of photovoltaic – Thermoelectric hybrid modules. *Appl. Energy*, 88(8): 2785-2790. <https://doi.org/10.1016/j.apenergy.2011.02.008>
- [13] Bjørk, R., Nielsen K.K. (2015). The performance of a combined solar photovoltaic (PV) and thermoelectric generator (TEG) system. *Solar Energy*, 120: 187-194. <https://doi.org/10.1016/j.solener.2015.07.035>
- [14] Wu, Y.Y., Wu, S.Y., Xiao, L. (2015). Performance analysis of photovoltaic-thermoelectric hybrid system with and without glass cover. *Energy Convers. Manag.*, 93: 151-159. <https://doi.org/10.1016/j.enconman.2015.01.013>
- [15] Rezanian, A., Rosendahl, L. A. (2017). Feasibility and parametric evaluation of hybrid concentrated photovoltaic-thermoelectric system. *Appl. Energy*, 187: 380-389. <https://doi.org/10.1016/j.apenergy.2016.11.064>
- [16] Ju, X., Wang, Z., Flamant, G., Li, P., Zhao, W. (2012). Numerical analysis and optimization of a spectrum splitting concentration photovoltaic – thermoelectric hybrid system. *Solar Energy*, 86(6): 1941-1954. <https://doi.org/10.1016/j.solener.2012.02.024>
- [17] Li, Y., Witharana, S., Cao, H., Lasfargues, M., Huang, Y., Ding, Y. (2014). Wide spectrum solar energy harvesting through an integrated photovoltaic and thermoelectric system. *Particuology*, 15: 39-44. <https://doi.org/10.1016/j.partic.2013.08.003>
- [18] Elsarrag, E., Pernau, H., Heuer, J., Roshan, N., Alhorr, Y., Bartholomé, K. (2015). Spectrum splitting for efficient utilization of solar radiation: A novel photovoltaic – thermoelectric power generation system. *Renewables: Wind, Water, and Solar*, 2: 16. <https://doi.org/10.1186/s40807-015-0016-y>
- [19] Mustofa., Djafar, Z., Syafaruddin., Piarah, W.H. (2018). A new hybrid of photovoltaic-thermoelectric generator with hot mirror as spectrum splitter. *Journal of Physical Science*, 29 (Supp.2): 63-75. <https://doi.org/10.21315/jps2018.29.s2.6>
- [20] Piarah, W.H., Djafar, Z., Syafaruddin., Mustofa. (2019). The characterization of a spectrum splitter of TechSpec AOI 50.0mm square hot and cold mirrors using a halogen light for a photovoltaic-thermoelectric generator hybrid. *Energies*, 12(3): 353. <https://doi.org/10.3390/en12030353>
- [21] Mustofa, Basri, Basri, H., Mahmudi, I., Jumiyatun., Hariyanto., Djafar, Z., Piarah, W.H. (2020). Low sun spectrum on simulation of a thin film photovoltaic, heat absorber, and thermoelectric generator system. *Journal of the Japan Institute of Energy*, 99(8): 88-93. <https://doi.org/10.3775/jie.99.88>
- [22] Hariyanto, H., Mustofa, M., Djafar, Z., Piarah, W.H.

- (2019). Mathematical modeling in combining photovoltaic and thermoelectric generator using a spectrum splitter. *EPI International Journal of Engineering*, 2(1): 74-79. <https://doi.org/10.25042/epi-ije.022019.13>
- [23] Piarah, W.H., Djafar, Z., Hariyanto., Mustofa. (2019). A new simulation of photovoltaic and thermoelectric generator hybrid with a beam splitter cold and hot mirror for low intensity. *International Review of Mechanical Engineering (I.R.E.M.E.)*, 13(9): 559-567. <https://doi.org/10.15866/ireme.v13i9.17884>
- [24] Suputra Widharma, I.G. (2020). Basic Programming and Application of LabVIEW. In *Bahasa Indonesia: Dasar Pemrograman dan Penerapan LabVIEW*. <https://www.researchgate.net/publication/344953903>, accessed on Dec. 2020.
- [25] Sodiq Ja'far. (2017). Simulation Performance Photovoltaics with SnO<sub>2</sub> Material. Physic Department, Science and Technology Faculty, State Islamic University Maulana Malik Ibrahim, Malang., Malang Indonesian.
- [26] Zainal, N.A., Apen, A., Yusoff, A.R. (2016). Modelling of photovoltaic module using Matlab Simulink. *IOP Conference Series: Materials Science and Engineering*, 114(1): 012137. <https://doi.org/10.1088/1757-899X/114/1/012137>
- [27] Honsber, C., Bowden, S. (2020). Equations for Photovoltaic. *PVEducation*. [Online]. <https://www.pveducation.org/pvcdrom/appendices/standard-solarspectra>.
- [28] Belkassmi, Y., Rafiki, A., Gueraoui, K., Elmaimouni, L., Tata, O., Hassanain, N. (2017). Modeling and simulation of photovoltaic module based on one diode model using Matlab/Simulink. *Proc. – 2017 Int. Conf. Eng. MIS*, pp. 1-6. <https://doi.org/10.1109/ICEMIS.2017.8272965>
- [29] Mawi, R., Kazuz, Y. (2014). Hybrid Solar Thermoelectric Systems for Combined Heat and Power. PhD Thesis, Cardiff University.
- [30] Schweber, B. (2020). Solar cells and power, Part 2 – power extraction. *POWERELECTRONIC TIPS*. [Online]. Available: <https://www.powerelectronictips.com/solar-cells-power-part-2-power-extraction/>.

## NOMENCLATURE

H	Power density, Wm <sup>-2</sup>
I <sub>PV</sub>	Rated Current in PV, A
I <sub>TEG</sub>	Rated Current at TEG, A
I <sub>ph</sub>	The generated photon current, A

I <sub>s</sub>	Diode current, A
I <sub>rs</sub>	Current resistance, A
I <sub>sc</sub>	Short circuit current, A
I <sub>MP</sub>	Current at maximum power, A
V <sub>OC</sub>	Voltage in open circuit, V
V <sub>PV</sub>	Rated voltage on PV, V
V <sub>TEG</sub>	Rated voltage at TEG, V
V <sub>MP</sub>	Voltage at maximum Power, V
P <sub>PV</sub>	Output power of PV, W
P <sub>TEG</sub>	Output power of TEG, W
P <sub>MP</sub>	Maximum power, W
R <sub>s</sub>	Series resistance, Ω
R <sub>sh</sub>	Parallel resistance, Ω
R <sub>TEG</sub>	Internal resistance of TEG, Ω
R <sub>LOAD</sub>	External resistance of TEG, Ω
T <sub>H</sub>	Hot side temperature, °C
T <sub>C</sub>	Cold side temperature, °C
G	Irradiation, W.m <sup>-2</sup>
G <sub>0</sub>	Standard irradiation, W.m <sup>-2</sup>
q	Electron charge, 1.602 x 10 <sup>-19</sup> C
k	Boltzman's constant, 1.38 x 10 <sup>-23</sup> J
κ <sub>i</sub>	Current conductivity, 0.0023 A/°C
ΔT	Temperature difference, °C
ΔV	Voltage difference, V
T	Temperature, °C
T <sub>0</sub>	Standard temperature, °C
A <sub>PV</sub>	Module surface area of PV, m <sup>2</sup>
A <sub>TEG</sub>	Module surface area of TEG, m <sup>2</sup>

## Greek symbols

λ	Wavelength
η <sub>PV</sub>	PV efficiency, %
η <sub>TEG</sub>	TEG efficiency, %
α	Seebeck Coefficient
k	Thermal Conductivity, W. m <sup>-1</sup> . K <sup>-1</sup>
t	Thickness of TEG, m

## Subscripts

AM1.5D	Air mass 1.5 Direct
PV	Photovoltaic
TEG	Thermoelectric Generator
I-V	Current-Voltage
P-V	Power-Voltage
FF	Fill Factor of PV
N <sub>s</sub>	Number of serial cells in PV module
N <sub>p</sub>	Number of parallel cells in PV module
E <sub>g</sub>	Energy gap (amorphous silicone = 1)
A	Diode ideal factor (amorphous silicone =1)

## ORIGINALITY REPORT

16%

SIMILARITY INDEX

%

INTERNET SOURCES

16%

PUBLICATIONS

%

STUDENT PAPERS

## PRIMARY SOURCES

- 
- 1** Daniel Parenden, Hariyanto. "Simulation of Photovoltaic Concentration with Fresnel Lens Using Simulink Matlab", European Journal of Electrical Engineering, 2019 **4%**  
Publication
- 
- 2** F Rheza Andika, Ahmad Al Afif, Putri Wulandari. "Design GUI Filter Infinite Impulse Response (IIR) for Noise Reduction While Real-Time Using Labview", 2021 IEEE International Conference on Communication, Networks and Satellite (COMNETSAT), 2021 **1%**  
Publication
- 
- 3** Muhammad Ahsan Iqbal Khan, Muhammad Irfan Khan, Ali Hussain Kazim, Aqsa Shabir et al. "An Experimental and Comparative Performance Evaluation of a Hybrid Photovoltaic-Thermoelectric System", Frontiers in Energy Research, 2021 **1%**  
Publication
-

4

Hayati Mamur, Rasit Ahiska. "Application of a DC-DC boost converter with maximum power point tracking for low power thermoelectric generators", Energy Conversion and Management, 2015

Publication

1 %

5

Cheng-Yu Peng, Ully Raihany, Shu-Wei Kuo, Yen-Zuo Chen. "Sound Detection Monitoring Tool in CNC Milling Sounds by K-Means Clustering Algorithm", Sensors, 2021

Publication

1 %

6

Innocent Nkurikiyimfura, Bonfils Safari, Emmanuel Nshingabigwi. "A Simulink Model of Photovoltaic Modules under Varying Environmental Conditions", IOP Conference Series: Earth and Environmental Science, 2018

Publication

1 %

7

Mustofa, Basri, Yuli Asmi Rahman. "Experimental investigation from different focal length of Fresnel lens on thermoelectric generators performance", IOP Conference Series: Earth and Environmental Science, 2018

Publication

1 %

8

Sajjad Mahmoudinezhad, Alireza Rezaniakolaei. "Thermoelectric generation using solar energy", Elsevier BV, 2021

Publication

1 %

9

Sarveshwar Singh, Onyebuchi Isreal Ibeagwu, Ravita Lamba. "Thermodynamic evaluation of irreversibility and optimum performance of a concentrated PV-TEG cogenerated hybrid system", Solar Energy, 2018

Publication

---

<1 %

10

Marcelo Montufar, Wilson Pavon, Manuel Jaramillo, Silvio Simani. "Solar Cell Mathematical Modelling Comparing Single and Double Diode Under Three Parameter Approach", 2021 IEEE PES Innovative Smart Grid Technologies Conference - Latin America (ISGT Latin America), 2021

Publication

---

<1 %

11

Philippe Revel, Nabil Jouini, Guillaume Thoquenne, Fabien Lefebvre. "High precision hard turning of AISI 52100 bearing steel", Precision Engineering, 2016

Publication

---

<1 %

12

Waleed Obaid, Abdul-Kadir Hamid, Chaouki Ghenai, Mamdouh El Haj Assad. "Design of a thermoelectric energy source for water pumping applications: A case study in Sharjah, United Arab Emirates", International Journal of Electrical and Computer Engineering (IJECE), 2021

Publication

---

<1 %

13

Carpentis, C.. "A study of water electrolysis with photovoltaic solar energy conversion", International Journal of Hydrogen Energy, 1982

Publication

---

<1 %

14

Challa Babu, P. Ponnambalam. "The role of thermoelectric generators in the hybrid PV/T systems: A review", Energy Conversion and Management, 2017

Publication

---

<1 %

15

T. Carstens, M. Corradini, J. Blanchard, Z. Ma. "Thermoelectric powered wireless sensors for spent fuel monitoring", 2011 2nd International Conference on Advancements in Nuclear Instrumentation, Measurement Methods and their Applications, 2011

Publication

---

<1 %

16

Chigbo Aghaegbusi Mgbemene, Howard Okezie Njoku, Cornelius Ogbodo Anayo Agbo. "Investigation of Parametric Performance of the Hybrid 3D CPC/TEM System Due to Thermoelectric Irreversibilities", Frontiers in Energy Research, 2018

Publication

---

<1 %

17

Monjur Mourshed, Subir Kumar Ghosh, Tariqul Islam, Nirendra Nath Mustafi. "Experimental investigation and CFD analysis of a solar hybrid PV/T system for the

<1 %

sustainable development of the rural northern part of Bangladesh", International Journal of Sustainable Energy, 2018

Publication

---

18

Sridhar Sripadmanabhan Indira, Chockalingam Aravind Vaithilingam, Kok-Keong Chong, R. Saidur et al. "A review on various configurations of hybrid concentrator photovoltaic and thermoelectric generator system", Solar Energy, 2020

Publication

---

<1 %

19

Zhu, Wei, Yuan Deng, Yao Wang, Shengfei Shen, and Raza Gulfam. "High-performance photovoltaic-thermoelectric hybrid power generation system with optimized thermal management", Energy, 2016.

Publication

---

<1 %

20

"Recent Advances in Electrical Engineering and Control Applications", Springer Nature, 2017

Publication

---

<1 %

21

"Thermoelectric Energy Conversion", Wiley, 2017

Publication

---

<1 %

22

Ershuai Yin, Qiang Li, Yimin Xuan. "A novel optimal design method for concentration spectrum splitting photovoltaic-thermoelectric hybrid system", Energy, 2018

<1 %

23

Hariyanto Hariyanto, Muhammad Rusdi, Daniel Parenden, Cipto Cipto, Klemens A. Rahangmetan. "Dye-Sensitized Solar Cell performance measurement analysis using Arduino Board", E3S Web of Conferences, 2021

Publication

---

<1 %

24

Khaled Teffah, Youtong Zhang. "Modeling and experimental research of hybrid PV-thermoelectric system for high concentrated solar energy conversion", Solar Energy, 2017

Publication

---

<1 %

25

Alireza Akbar, Gholamhassan Najafi, Shiva Gorjian, Alibakhsh Kasaeian, Mohamed Mazlan. "Performance enhancement of a hybrid photovoltaic-thermal-thermoelectric (PVT-TE) module using nanofluid-based cooling: Indoor experimental tests and multi-objective optimization", Sustainable Energy Technologies and Assessments, 2021

Publication

---

<1 %

26

Samson Shittu, Guiqiang Li, Xudong Zhao, Xiaoli Ma. "Series of detail comparison and optimization of thermoelectric element geometry considering the PV effect", Renewable Energy, 2019

Publication

---

<1 %

27

De Soto, W.. "Improvement and validation of a model for photovoltaic array performance", Solar Energy, 200601

Publication

<1 %

28

T. T. Chow, G. N. Tiwari, C. Menezo. "Hybrid Solar: A Review on Photovoltaic and Thermal Power Integration", International Journal of Photoenergy, 2012

Publication

<1 %

Exclude quotes On

Exclude matches < 5 words

Exclude bibliography On